



# **USER MANUAL**

**LEVELING SYSTEM OPERATION  
FOR CENTRAL AND QUAD PUMP  
SYSTEMS FOR MOTORIZED OR  
BUMPER PULL APPLICATIONS**

**[BIGFOOTLEVELER.com](http://BIGFOOTLEVELER.com)**

**Quadra Manufacturing Inc.**

305 US 131 SOUTH  
WHITE PIGEON, MI 49099

800-752-9815 (PHONE)

269-483-9636 (FAX)

**1st Identify your leveling system...** There are two four point system types: central pump (one pump with a manifold and valve assembly to the left of the motor) and the quad pump (four smaller power units). Then follow the manual by looking for titles of your specific system. Start with mounting the cylinders, then tank assembly, install hydraulic hose and wiring harnesses, electrical controls, finally hook to battery, test and bleed lines.

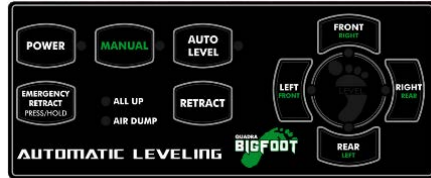

## Automatic System

Page 2-7

Automatically levels the vehicle with supreme precision.

Manual operation feature.

All-up & Ignition safety feature.

Emergency Retract operation.

Lifetime warranty on cylinders.

Central & Quad Pump Formats.

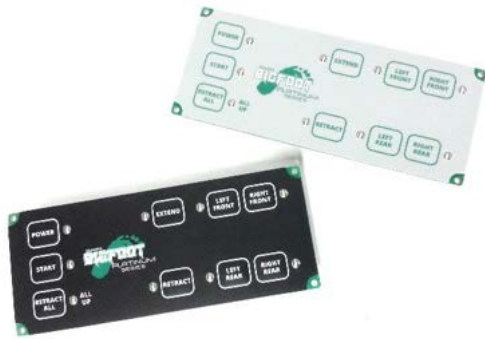

## Platinum System

Page 8-10

Automatically deploys all four jacks to level the vehicle from front to rear.

Manual operation feature.

All-up & Ignition safety feature.

Simple, no nonsense design.

Central Pump System.



## Manual System

Page 11

Operates jacks individually or all at once.

All-up safety feature.

Emergency Retract operation.

Quad Pump System.

# Automatic Leveling Control

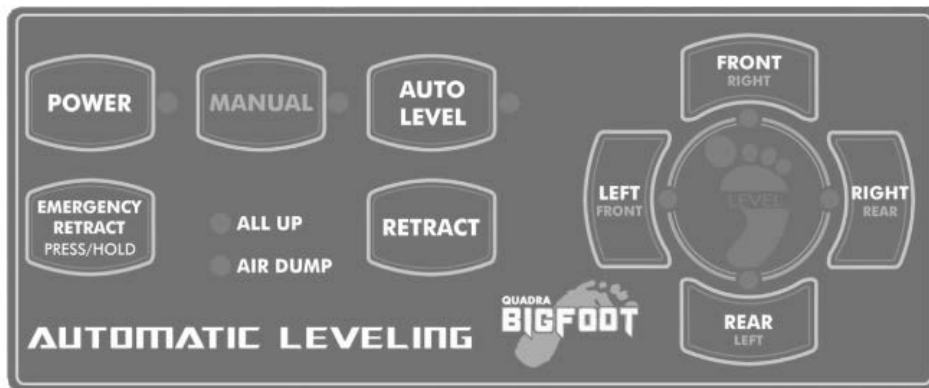

**CAUTION WHEN OPERATING:**  
Rear tires must maintain contact with the ground as the bolt-on system is not designed for this and the jacks may shift. Front tires are typically OK to leave the ground, as they may need to do so to level.

**IF ALL LIGHTS ARE FLASHING, SEE "PROGRAMMING OR ZERO MODE"**

## Operation:

Vehicle ignition/accessory must be OFF in order to auto level or extend the jacks.

Make sure slide outs are retracted prior to operating leveling system to avoid damaging slide outs.

System is not tied to vehicle parking brake.

Panel will shut off automatically after 5 minutes of no use.

Panel will turn on automatically after ignition is turned on, safety feature to monitor that cylinders are retracted.

1. Turn panel/system on and let system run through its diagnostic mode. Lights will flash clockwise around the green foot on right side of panel.
2. To Auto level: When the lights stop flashing, simply press the AUTO button once and release. There can be no movement in the coach during this 60-90 second process, best if operated from outside vehicle or sitting still inside.
3. If choosing Manual Mode, press and hold the MANUAL button until light comes on. Now each button on the right will extend the corresponding cylinder. When in the MANUAL mode, each leveler may be operated individually. FRONT operates right front. RIGHT operates right rear. REAR operates left rear. LEFT operates left front. When using this feature it is important to level the coach by using two levelers at a time or small individual increments to avoid twisting the RV body. For example, right front and right rear, this puts less stress on the frame. To individually retract, press the RETRACT button and the cylinder button simultaneously. Turn panel off when finished.
4. To retract the levelers: Simply turn the panel on and press and release the RETRACT button. The pump will shut off when all four cylinders are fully retracted and the ALL UP light comes on. Always do a visual check to verify all four cylinders are completely retracted. If one or more cylinders are not fully retracted and the ALL UP light is on, press and hold the EMERGENCY RETRACT button until they are all retracted and see troubleshooting section to identify what may be going on.
5. The EMERGENCY RETRACT button, this is used to override the electronic safety features built in the control to retract all four cylinders simultaneously. You will need to press and hold this button until all four are retracted completely, once released the panel will shut off. As long as there is enough voltage in the house batteries to turn the motor, this button will retract the cylinders.



FRONT RIGHT & REAR LEFT LIGHTS FLASHING, THIS MEANS LOW VOLTAGE TO CONTROLS, PANEL INOPERABLE EXCEPT EMERGENCY RETRACT, SEE "LOW VOLTAGE CODE" ON NEXT FEW PAGES.

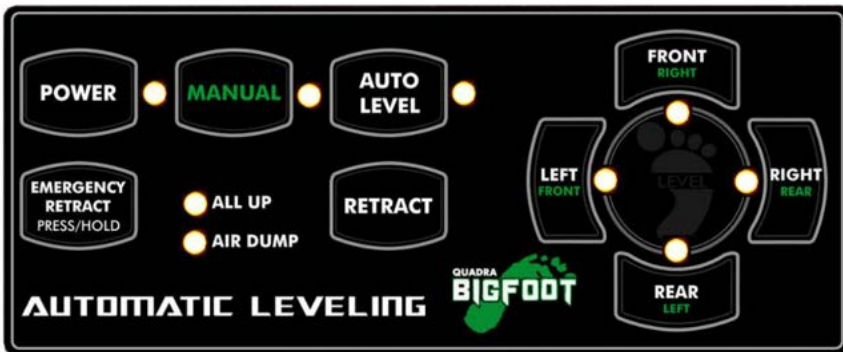

ALL LIGHTS ARE FLASHING, THIS MEANS PANEL IN ZERO OR PROGRAMMING MODE, SEE NEXT PAGES. SOME FUNCTIONS INOPERABLE UNTIL OUT OF THIS MODE. CAN PRESS EMERGENCY RETRACT TO QUICKLY EXIT.

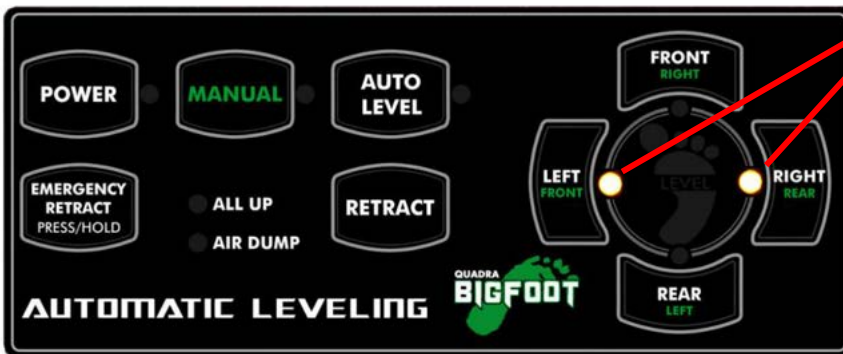

LEFT FRONT & RIGHT REAR LIGHTS ARE FLASHING, THIS MEANS SYSTEM TIMED OUT, STROKED OUT, OR HAD MOVEMENT DURING AUTO LEVEL. PRESS RETRACT. SEE "TIMED OUT CODE" ON NEXT PAGES.



IF ONE OR MORE OF THESE LIGHTS ARE FLASHING IN ANY ORDER OTHER THAN LISTED ABOVE, NOTHING IS WRONG. THEY ARE INDICATING THE LOW POINTS OR "LEVEL STATUS" OF THE VEHICLE.

**IF "AIR DUMP" LIGHT FLASHING...**

STORING PROGRAM, WAIT FOR BIGFOOT LIGHT TO COME ON.

**IF "AUTO LEVEL" LIGHT IS ON...**

SYSTEM RUNNING AUTOLEVEL PROGRAM, WAIT TO FINISH OR RETRACT.

**PANEL TURNS ON, WHEN IGNITION TURNED ON...**

NORMAL, PANEL WILL SHUT OFF 5 MINUTES AFTER IGNITION IS OFF, EXTEND FUNCTIONS DISABLED.

## Programming mode or “all lights flashing on panel”

When all the lights are flashing on the panel, this means the control is in programming or zero mode. This is where the user sets the level program in the controller. When the panel is first installed or hooked to power, it will enter this mode automatically. To quickly get out of this mode (if program has already been set) just press the POWER button or EMERGENCY RETRACT button to shut panel off.

### To Program Level Position

If all lights are flashing move to step 3.

1. Make sure all four cylinders are retracted, if they are move to step 2. If not, turn panel ON, let diagnostic lights flash until they stop (within 30 seconds). Press RETRACT button, when all up light comes, move on.
2. Enter zero or programming mode by turning the panel on, diagnostic lights will cycle, then press FRONT RIGHT (top button over Bigfoot logo) button five times, then REAR LEFT button five times (not too fast or too slow, standard second count).
3. All lights will come on, you are in zero mode. Press and hold each cylinder button (Ex. FRONT RIGHT) individually until the cylinder touches the ground, then STOP. Run the next cylinder, press and hold, stop once it touches the ground.

*Keep in mind to avoid twisting RV body with individual adjustments.*

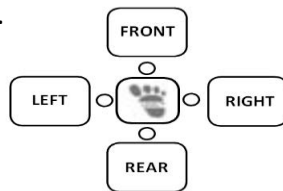

**FRONT** indicator operates the right front.

**RIGHT** operates the right rear.

**REAR** operates the left rear.

**LEFT** operates the left front.

4. Once all four are on the ground, you must choose a level reference point. This is where the controls will level to on your vehicle. Examples include corner of counter top near controller, floor just in front of step, etc. But you must only choose one spot. Place a bubble level on the reference point of the vehicle you want to level, Example: floor in front of the entry step. Place level so it is reading front to rear.
5. Find the low end and extend the corresponding cylinders individually until the bubble reads level front to rear, you can do small increments individually or in pairs, make sure you let coach settle before continuing to lift (coach will shake). Once bubble level is level front to rear do the same for left to right. Keep in mind, when programming you want to use as little of cylinder travel as possible.
6. Once level in both directions, verify that all four cylinders are touching the ground, if not bump a cylinder, re-check level. If satisfied, next step.
7. Press the RETRACT button three times, this stores the program. Wait until the Bigfoot icon LED comes on (AIR DUMP light will flash, just wait). Once the foot light comes on, press RETRACT to retract cylinders. If you do not want to store program, just turn panel off or press EMERGENCY RETRACT.
8. Panel is now programmed, now every time you press AUTO it will come to this position. Can always be re-programmed. If loss of power occurs or sensor is unplugged, sensor will still have program stored.

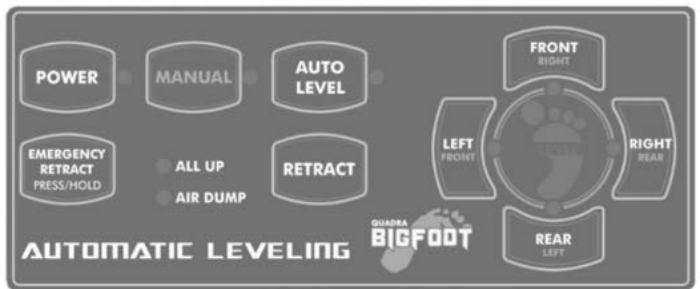



## **ALL UP Light**

Light comes on when all four limit switches have been made. This is a normally closed circuit, limit switch mates and circuit opens, ALL UP light comes on. Wired in series so light will go off if only one switch is not made.

## **Bigfoot Light**

Shaped like a footprint, it comes on solid when auto level process is complete or successful. Light will flash when coach is “near” level position, however auto level program may not be finished yet.

## **Audible Alarm**

Alarm will sound (sounds like seat belt alarm) when the ignition or accessory is on and there is no ALL UP light. This means that one or more of the cylinders are not fully retracted. If this happens, press and hold EMERGENCY RETRACT until the alarm goes off or shut ignition off and retract the system. If the alarm does not shut off, this could mean that one of the footpads came up at an angle (pivoting dome design can interfere with solid connection if not straight) or that one of the pins are bent and are not making contact with the switch. Extend each cylinder individually, and inspect, then press RETRACT (not in manual mode) so that all cylinders retract. Check for ALL UP light. If not, repair switches by removing with 7/8” wrench and cleaning with WD40 (spherical ball switch), then try again.

To temporarily get rid of alarm: After retracting each cylinder with emergency retract button, temporarily disconnect (unplug) two spade connectors on switch at particular cylinder (located near footpad) OR unplug control panel or leveling sensor to eliminate alarm from beeping as long as you have confirmed cylinders are retracted. Then repair switches and return to proper installation. This is for disabling alarm only while camping, Quadra does not recommend putting the vehicle in gear with this setup.

## **Pump does not shut off when cylinders are fully retracted...**

If you have an ALL UP light and pump will not shut off once light is on, then there may be damage to the harness during installation (screw or p-clip smashing wires causing short). Send replacement harness or inspect harness along subframe beams underneath coach (we have found this issue before with the p-clips smashing harness or screwed into looming/harness). User can shut pump off by pressing EMERGENCY RETRACT.

If you do not have an ALL UP light, then a limit pin is bent or damaged not making contact with a limit switch, check pins near footpads on each cylinder. If one is bent, they can be straightened, remove with 7/8” wrench. OR for temporary solution the limit switch itself can be unplugged (two spade connectors) and use EMERGENCY RETRACT to completely retract all four cylinders.

## **One or two cylinder lights on right side of panel on or flashing...**

**FRONT RIGHT, RIGHT REAR, REAR LEFT, LEFT FRONT:** any one or two of these buttons operate corresponding cylinders, the lights however will indicate the low points of the coach at all times, so when one or two of them are on or flashing, the control is just indicating to the user where the low point is. However, if FRONT & REAR or RIGHT & LEFT flash this means there is an error code (see troubleshooting) as opposite ends of the coach cannot both be the lowest points.

## Panel Troubleshooting

The FRONT, RIGHT, REAR or LEFT cylinder lights are flashing. This is indicating the low points of the coach as it sits, nothing is wrong with the control; it is constantly monitoring the level status of the vehicle.

Our panel will shut off by automatically after five minutes of no use. Panel will also turn on automatically when the ignition turns on, this is a safety feature monitoring the cylinder position (making sure they are retracted) and is only drawing power for the two LED's. The panel will shut off again after five minutes by itself after no use or ignition shuts off. With the ignition on, the panel power lights can be shut off, but the ALL UP light will stay on for safety.

**LOW VOLTAGE CODE: FRONT and REAR lights flashing**, control is seeing low voltage (less than 9.5-10v). Shut the panel off. Charge the house batteries, when they supply enough voltage, try system again (at least 15 minutes). If low voltage code comes on again, or never goes away, you may have to unplug the interface harness (between the panel and sensor) at the back of the control panel or the front of the sensor to clear the error code. Repeat battery charging. See location chart on last few pages next to picture of leveling sensor.

**TIME OUT CODE:** When AUTO leveling, if the **LEFT and RIGHT lights are flashing**, the system timed out, or there was movement in the coach during auto leveling or the cylinders ran out of stroke in order to reach level (re-park or add blocks to low corner cylinders).

If there is **no ALL UP light**, and the vehicle ignition turns on, the panel's alarm will sound. The alarm cannot be shut off until: The ignition is shut off **or** the ALL UP light comes on. The ALL UP light is tied to each cylinder's limit switches in the wire harness (grounded in-series circuit, normally closed limit switches, once limit switch mates circuit is broken and ALL UP light comes on). If one switch is not made the ALL UP light will not come on. Press the RETRACT button to retract the cylinders, pump will run until the ALL UP light comes on or 2 minutes.

If you get a **false ALL UP light (light on but one or more cylinders not fully retracted)**, check the wire connectors at all the limit switches, they are male and female spade connectors, they may have a poor connection or not plugged in all the way. If the connections are good then there may be moisture/rust in the limit switch or it is defective. Press and hold the EMERGENCY RETRACT button to retract the cylinders and override the limit switches, once button is released panel will shut off. Sometimes the limit switches can be taken off and cleaned, sprayed with WD40. Part #M50103FLAT to order replacement limit switch and pin, need 7/8" wrench only, wires are spade connectors (plug/unplug).

**If you do not get an ALL UP light but cylinders are retracted**, press and hold EMERGENCY RETRACT to see if that works. Otherwise, there could be a limit pin bent or missing/loose footpad not allowing pin to make contact with limit switch. Straighten pin or re-attach a footpad (if missing, disconnect limit switch wires to open the circuit). See Fig.4 for schematic or part #'s. If customer has access to hardware store, a ¼" vacuum cap can be placed under pin to help reach bent footpad. Customer can also disconnect wires on limit switch to open circuit (this will give you a false ALL UP light).

## Limit Switches

We use a mechanical ball switch for our cylinder retract indication. This simple normally closed switch is on a grounded circuit, when the limit switch is made it breaks the circuit (for the light to come on). These switches can get road debris, rust, etc. inside the ball switch itself and make the switch stick. Also the pins can bend from contact with the footpad hitting a curb or parking lot during your drive. These parts are simple in design and replacement and fairly in-expensive compared to competition's internal pressure switch located inside the pump assembly on the manifold buried underneath the vehicle. See Limit Switch Maintenance page.

**Panel won't turn on, system won't run, clicking noise, FRONT & REAR lights flash...**

Battery low, panel won't turn on = coach battery, the system relies on the house battery. The battery needs to be nearly 100% charged for the system to work, it doesn't make a difference if the coach is new, that doesn't mean the battery is fully charged or even good. Batteries don't charge instantaneously, so one can't just expect to hook it up to a charger and the system will work immediately, if the battery is good, then the unit might have a ground issue. Auto systems may require user to un-plug/re-plug the interface cable to clear code on panel regardless, newer versions do this automatically and do not need to be unplugged.

**CONTROL PANEL**



**#M37055**

**LEVELING SENSOR**



**#M37061 "AUTO LEVEL EZ"**

**#M37054 "CLASS C LEVELER"**

**#M37060 "AUTO MANUAL LEVELER"**



# Platinum Control

("PC" part #'s) Panel Operation Manual Version C

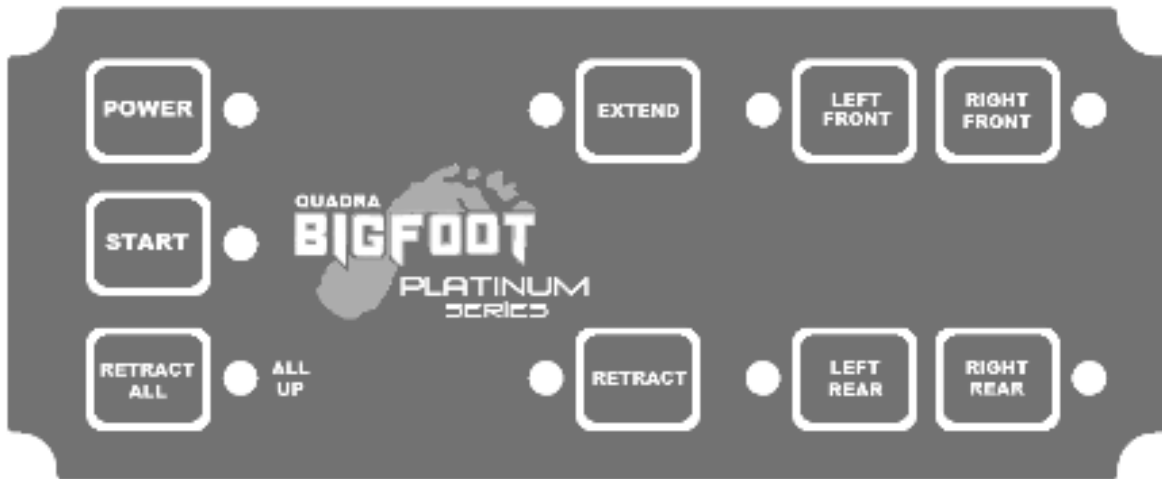

## Operation on next page, but here are some Platinum Panel operational notes...

System typically connected to the RV "house" batteries.

The POWER, START and RETRACT ALL buttons have a 1-2 second hold time for safety (in case button was unintentionally bumped).

The START function (jacks automatically deploy) and EXTEND mode are disabled when the ignition is on for safety. The RETRACT features still work in case need to use engine to boost battery voltage when ready to leave.

The panel will shut off automatically after 10 minutes when there are no buttons pressed.

The panel will turn on automatically when the ignition is on, and will not power off until the ignition is off.

The panel will shut off automatically after 10 minutes from the ignition is shut off.

If all the LED's flash for one second and the panel turns off, the panel is receiving less than 9.5 Volts and you need to charge your house batteries.

If the "All Up" LED is flashing after you press RETRACT, then one or more of the cylinders did not get retracted, just press RETRACT one more time, once the "All Up" LED comes on solid all cylinders are safely retracted. Still do a visual check for safety.

If using the manual modes, example RETRACT mode, it is better to level by bringing the vehicle/trailer UP not DOWN. Recommend only use EXTEND mode manually.

### CAUTION WHEN OPERATING:

Rear tires must maintain contact with the ground as the bolt-on system is not designed for this and the jacks may shift. Front tires are typically OK to leave the ground, as they may need to do so to level.

Replacement part #M37905

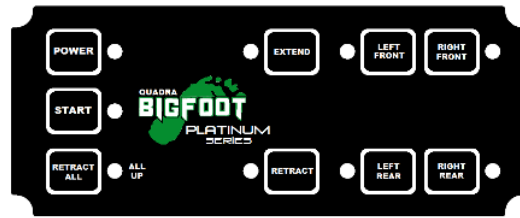

**CAUTION WHEN OPERATING:**  
Rear tires must maintain contact with the ground as the bolt-on system is not designed for this and the jacks may shift. Front tires are typically OK to leave the ground, as they may need to do so to level.



Adjustment Buttons

All Up Light (when constant, indicates when all four cylinders are retracted)

## Extend System:

1. Press the & hold the **POWER** button for one full second. Red LED next to button will come on constant.
2. Press the & hold the **START** button for one complete second, release when the light comes on or you hear the pump. **OR** Skip to step 4 to operate manually. The start function brings the front of the vehicle nearly level to the rear and stabilizes the rear as well. LED next to the START button will come on until program is finished, pressing any button during operation will cancel program. Vehicle Ignition must be OFF. Designed for 6-9" cylinder ground clearance, longer ground clearance may not allow all four cylinders to reach the ground. In this case you may want to skip to step 4.
3. **Done!** Vehicle is now stabilized, *if* additional adjustments are desired, move to step 4. If you are satisfied with where the vehicle/trailer is, move to step 6.
4. Press the **EXTEND** button. Control is now in "Extend Mode" LED next to button will come on. Release button. For adjustments it is always better to bring the vehicle/trailer UP rather than DOWN. Identify the low point, and raise that low point by using the buttons below in pairs or individually to address the low point.
5. Press & Hold the two or one of the adjustment buttons for the designated end or corner of the vehicle that is low or high. *NOTE: Take care not to run individual cylinders for large increments, this can damage your RV/frame/trailer by twisting the frame or RV body. Example: If the front end of the vehicle/trailer is low, press and hold both RIGHT FRONT & LEFT FRONT adjustment buttons until the front of the vehicle/trailer is more level. If the Right or Curb side is low, press & hold the RIGHT FRONT & RIGHT REAR simultaneously until level, passenger's side is considered the right side for reference.). If doing individual adjustments, make sure they are small increments to avoid any twisting of the frame or RV body.*
6. Press & hold the **POWER** button for one to two seconds to turn the panel off. The panel will automatically shut off after 10 minutes of no activity or press POWER button, LED will go off.

## Retract System:

---

1. Press & hold the **POWER** button for one to two seconds to turn the panel on, the red LED will come on next to the button.
2. Press & hold the **RETRACT ALL** button for one to two seconds, then release. You will hear the pump engage. This will run the pump until the green “**All Up**” light comes on constant. This process will take up to 60 seconds. After 60 seconds the green light will flash, this means that one or more of the jacks did not fully retract. In this case, simply press RETRACT button one more time, make sure the LED goes constant before traveling (still recommend doing a visual check). If you have a false all up light (one or more jacks are not fully retracted and the light is on, you may have defective limit switch) to retract override, press RETRACT, then press & hold the corresponding button for that particular jack (version B or later only).
3. Press & hold the **POWER** button for one to two seconds to turn the panel off. The panel will automatically shut off after 10 minutes of no activity or press POWER button, LED will go off.

***Hear an alarm?*** *If the ignition is ON and the ALL UP light is OFF, the panel will sound an alarm (sounds like a seat belt beep). This will occur until you shut the engine off or the ALL UP light turns on. This is done by going in RETRACT mode and pressing all four buttons (one at a time) for a few seconds to see if the alarm shuts off. This can be done with the engine on. If the ALL UP light does not come on, visually inspect each cylinder and limit switch as there may be a defective limit switch, bent limit switch pin, loose footpad, etc.*

***Always do a visual check to verify that all the jacks are fully retracted prior to operating the vehicle. If one or more cylinders are not fully retracted, you may have a defective or jammed limit switch. Go into RETRACT mode, and press and hold that particular cylinder until it has retracted (you will hear the pump change tone).***

***Platinum systems come with a one year limited warranty. If you ever have any questions or issues please feel free to call and speak with someone in tech support at Quadra Manufacturing, 800-752-9815.***

# Quad Pump Manual Control

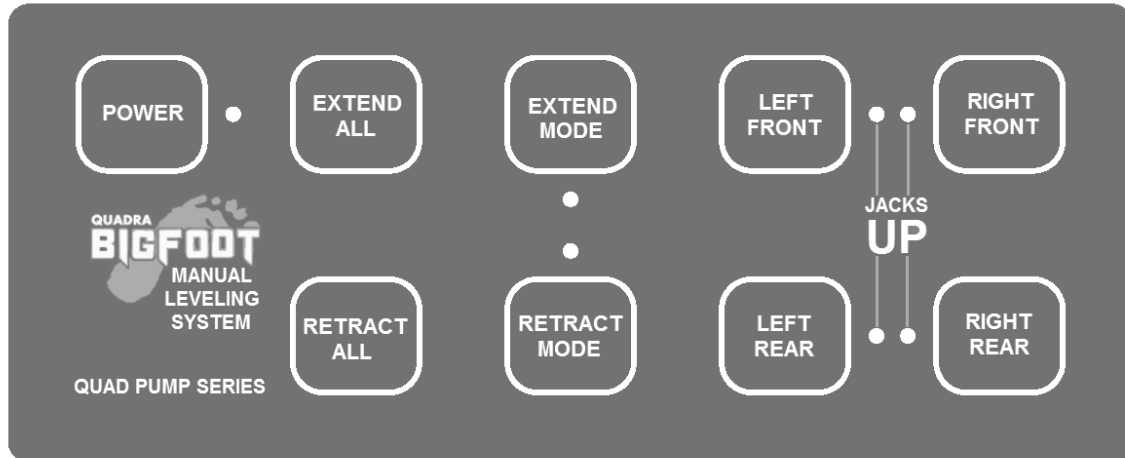

Simultaneous and individual operation makes this control great for many applications.

Individual all up indication when each cylinder is fully retracted, (“JACKS UP” lights).

Ignition safety feature, disables extend functions when ignition is on.

One touch retract (all four jacks), automatically cuts power to each pump as they retract.

Ignition alarm if one or more jacks are not fully retracted when ignition is on, audible alarm will sound.

**Extend All:** Press & hold to extend all four jacks simultaneously.

**Retract All:** Retracts all four simultaneously until all four “JACKS UP” lights turn on. Always visually check that all jacks are fully retracted prior to operating the vehicle. If you have an all up light, but one of the cylinders not fully retracted, enter Retract Mode, and operate that cylinder (see instructions below, then see limit switch maintenance when ready to look at this further).

**For individual operation:** Press and release Extend Mode button, press and hold corresponding jack you want to extend. Do the same for retract function. In case of limit switch failure or “false all up light” (jack not fully retracted but it’s “up” light is on)... Press Retract Mode and run that particular jack to override the limit switch, then replace switch and pin.

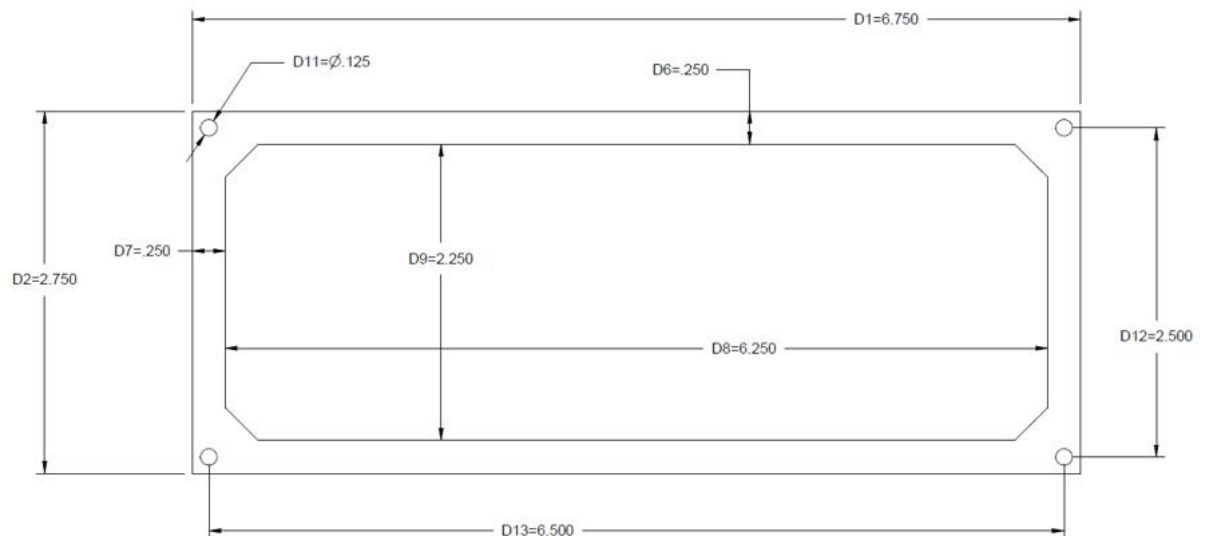

Replacement #M37002

# General & Limit Switch Maintenance

For most Bigfoot landing gear and leveling systems...

#1. Check the power supply to the Bigfoot system, RV house batteries, diesel chassis battery, trailer battery, etc. Test the voltage under load by using a volt meter and test your voltage with the system pump operating, if this drops below 10-11 volts, you may need to look into replacing the battery or batteries. If voltage is good under load, you may need to replace or check other connections on the pump assembly, including the power wire (connected to copper strip) and the ground from the pump to the frame. Our pumps ground at the solenoid mounting flange and contact between the pump steel housing and the frame it is bolted to, and has a 10 ga. cable that connects the tank body to the frame, typically only 3-6 ft long.

#2. Inspect and maintain the limit switches (if equipped) for each cylinder. See diagram on the right to identify the limit switch. These can be removed with a 7/8" wrench. To pro-long the life of the switch, remove and apply di-electric grease on the ball itself and the limit pin. These are normally closed switches and are tied to your "All Up" indication, Retract function, and ignition safety alarm on your panel (if equipped).

#3. Check for fluid leaks on the ground, footpad, hose, fittings, etc. Our systems use ATF so the fluid should be red in color. If leak found, locate the origin and check fluid level inside the pump assembly, fluid level should be between 1-1.5" below the top of the reservoir, central pump 4pt systems can be 1.5-2" below the top.

#4. If your cylinder chrome shaft/rod is exposed (not a square jack), spray dry teflon spray on the shaft when leaving for long period of time, more frequently if by the ocean or salty environment.

#5. After a few uses, check all the hardware for cylinder mounting and pump mounting, re-torque to proper specs to make sure the bolts did not come loose. 3/8" & 7/16" hardware to 70 ft/lbs., 1/2" hardware to 100 ft/lbs., if bolt-on system, note any frame or bracket deformation prior to reaching full torque spec. (some deformation is OK, as long as the structure & function of component is still intact).

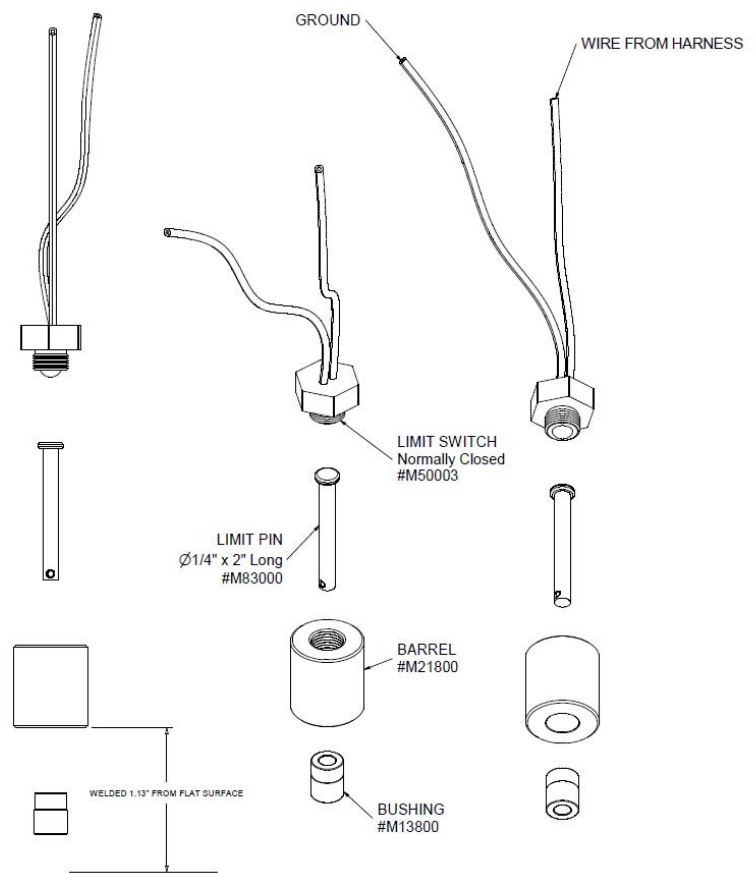



# Common Troubleshooting...

## Most tech support common calls

Most issues we receive are power related. Always check power and ground wire connections first. Check power level of battery under load (place volt meter on battery then press and hold EMERGENCY RETRACT on control to see if voltage drops).

## Alarm going off with engine on

Typically this means one of the cylinder limit switches sent the signal to the controller that it was “up” before it was 100% retracted (footpad tight to bottom). So when you hit a bump or vibration while driving, this caused the limit switch pin to loose contact and sound the alarm. First visually inspect and make sure they are all retracted, then do the following: **Auto system:** *Press & hold EMERGENCY RETRACT button for a few seconds, you will hear the pump change tone or ALL UP light to come on.* **Platinum system:** *Enter RETRACT mode, then press and hold each cylinder button individually for a few seconds, listen for pump change tone or ALL UP light to come on.*

## System will not operate with engine on

Our systems are NOT designed to extend with the engine on for safety. They will also not automatically retract when the engine comes on.

## Cylinders not lifting or holding pressure

This means there is more than likely air in the system (not bleed during installation). Two methods, easy method is to enter manual mode and completely extend all four cylinders to full extension and leave for an hour, then retract, wait another 30 minutes before operating again. If this does not fix the issue then the **secondary bleeding procedure** must be done, see below for instruction.

## Cylinder will not operate, extend or retract...

Attempt to bleed system first, verify that it will not operate in either direction. Then check all wires at the leveling sensor to make sure they are inserted properly in the plug at the back of the sensor (wires may be loose in connector). If this is all good, then the corresponding valve/coil may be defective, in tank assembly check valve ground wire (to solenoid mounting bolt) and wire connection to wiring pigtail. If valve bad, part #M35008, take care replacing do to ease of crushing valve assembly on re-installation.

## Secondary air bleeding process

If there is still air in the system, a more strategic method may be required. Loosen all four extend hose fittings (15mm wrench) on the jacks (located near the top of each cylinder), enough that fluid and air can escape. Enter manual mode on panel (press and hold MANUAL for 3 seconds until light comes on). Press and hold each cylinder until solid fluid comes out of each fitting. Tighten fittings and repeat for retract hose fittings to ensure all air is out, to retract cylinders in manual mode, press each cylinder and the RETRACT button simultaneously. Re-tighten all fittings and clean up mess. This method can also be done by placing each line in a bucket to minimize mess afterwards. *In some instances, the front jacks may need to be dis-mounted from underneath the cab to access the top extend ports during the bleeding procedure.*

## CAUTION WHEN OPERATING:

Rear tires must maintain contact with the ground as the bolt-on system is not designed for this and the jacks may shift. Front tires are typically OK to leave the ground, as they may need to do so to level.

# Cylinder Identification...

**8k SERIES**  
 CYLINDERS RATED AT 8,000 LBS. LIFT CAPACITY



**#M0211**  
 15" long retracted  
 Chevy 4500 Front  
 Ford E-350 Front

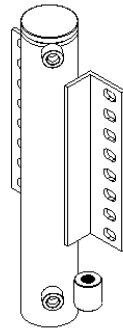

**#M0213-F**  
 17" long retracted  
 Ford E-350 Front

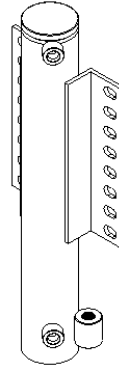

**#M0213-R**  
 17.5" long retracted  
 Ford E-350 Rear

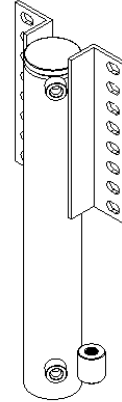

**#M0213-OCR**  
 18.5" long retracted  
 Transit Rear

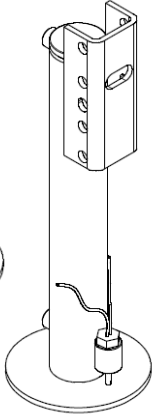

**#M0213-OCF**  
 17" long retracted  
 Transit Front

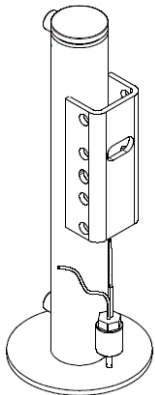

**#M0211S**  
 15" long retracted  
 Sprinter Van Rear  
 Mounting brackets  
 may be flush to top.

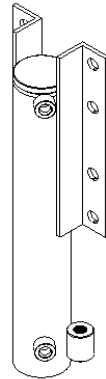

**#M0213-RC**  
 17" long retracted  
 Sprinter Front & Rear  
 Sprinter Van Front

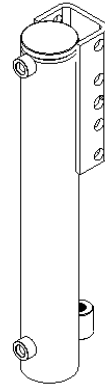

IF 6" Round Footpad  
 (like shown to the left)  
**#M0213-OC**

# Cylinder Identification...

**12k SERIES**  
CYLINDERS RATED AT 12,000 LBS. LIFT CAPACITY

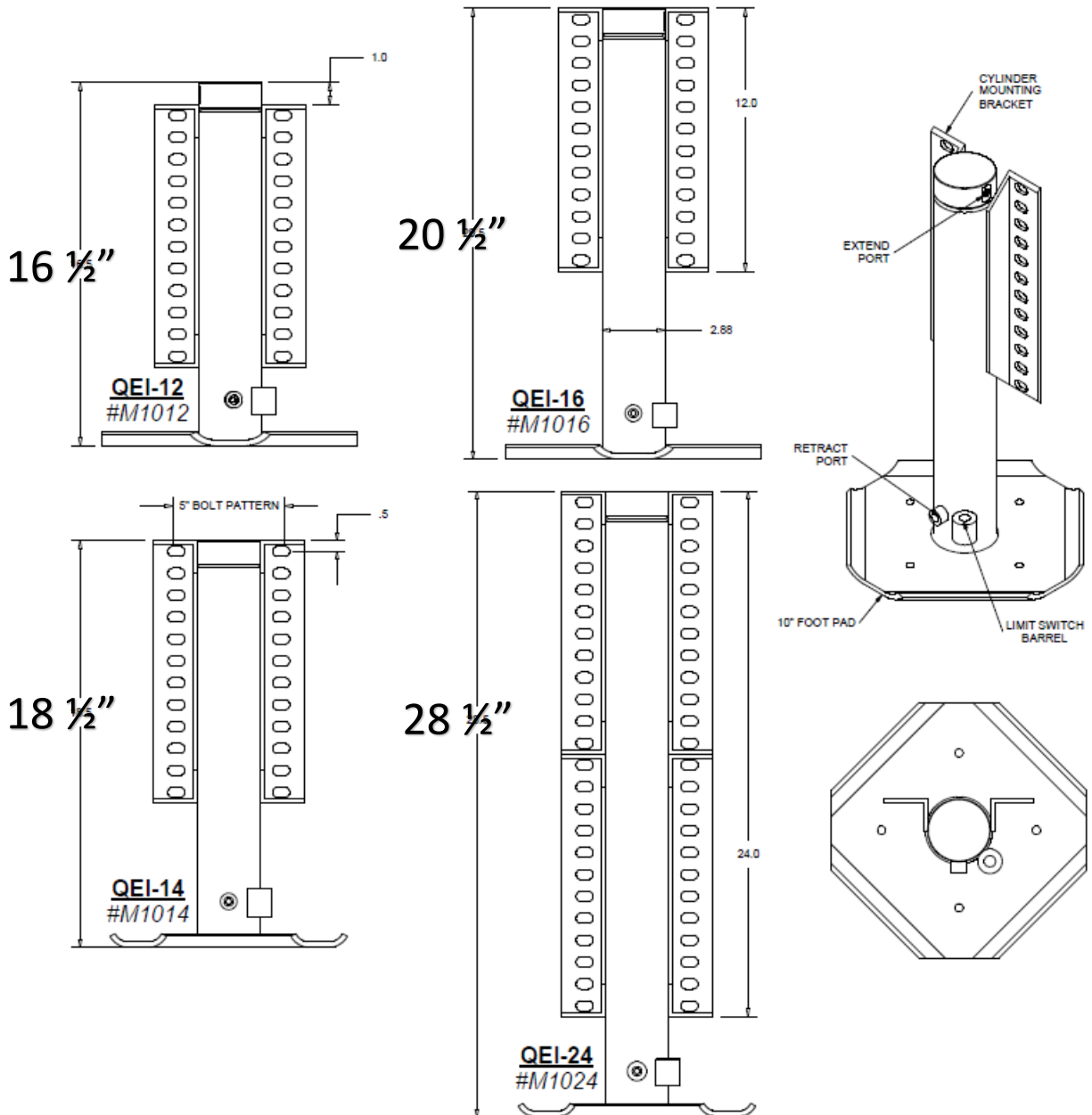

# Cylinder Identification...

**17k SERIES**  
CYLINDERS RATED AT 17,000 LBS. LIFT CAPACITY

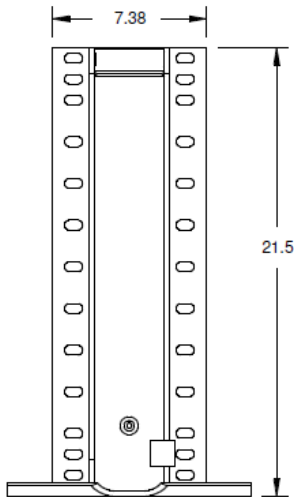
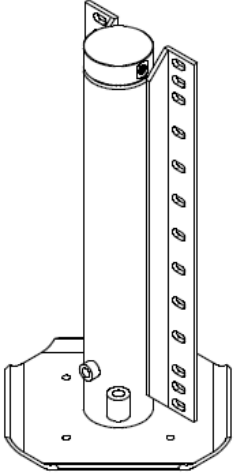

**QEII-21**  
**#M7000**  
15" STROKE

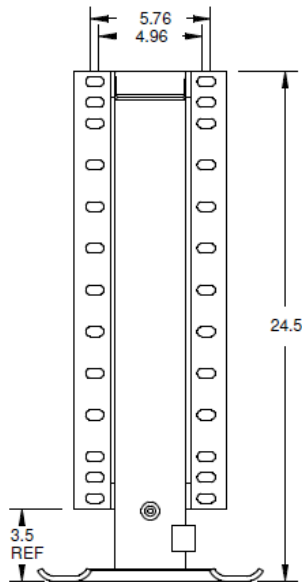

**QEII-24**  
**#M1300**  
18" STROKE

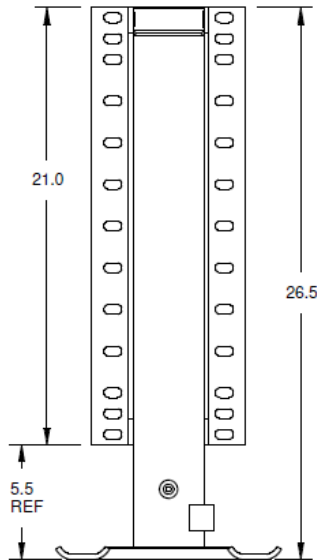

**QEII-26**  
**#M8000**  
20" STROKE

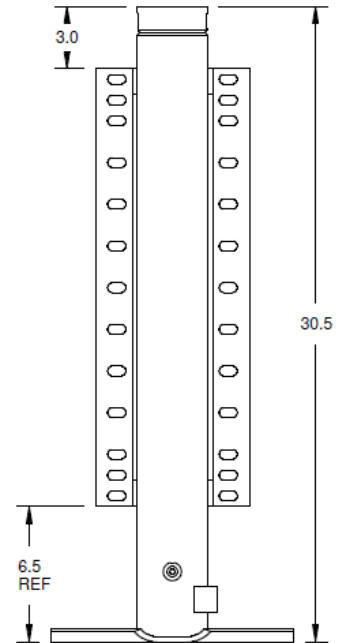

**QEII-30**  
**#M9000**  
24" STROKE

## Central Pump Systems...

Tank Assembly will be pre-assembled & pre-wired direct from factory.

- Mount the pump using a minimum of two 7/16" bolts, nuts & lock washers.
- Plumbing is shown in Fig. 2 below, use 9/16" wrench and be careful not to under or over-tighten the hydraulic fittings. Sometimes marking the hydraulic lines with tape may make it easier.
- **DO NOT** install the top extend lines to the jacks themselves yet, this will be done later in installation.
- The main wire harness will plug directly into the 14-pin connector that is pre-wired to the assembly.
- Route the **ground cable** (attached to ground shown below) to a grounded surface on the vehicle frame.
- Finally installing the plastic three sided tank cover, this should be done later on in the assembly.
- The tank cover will need to be trimmed to your liking around the hydraulic lines. Fasten the tank cover with at least two self-threading screws, be careful not to puncture the plastic reservoir.

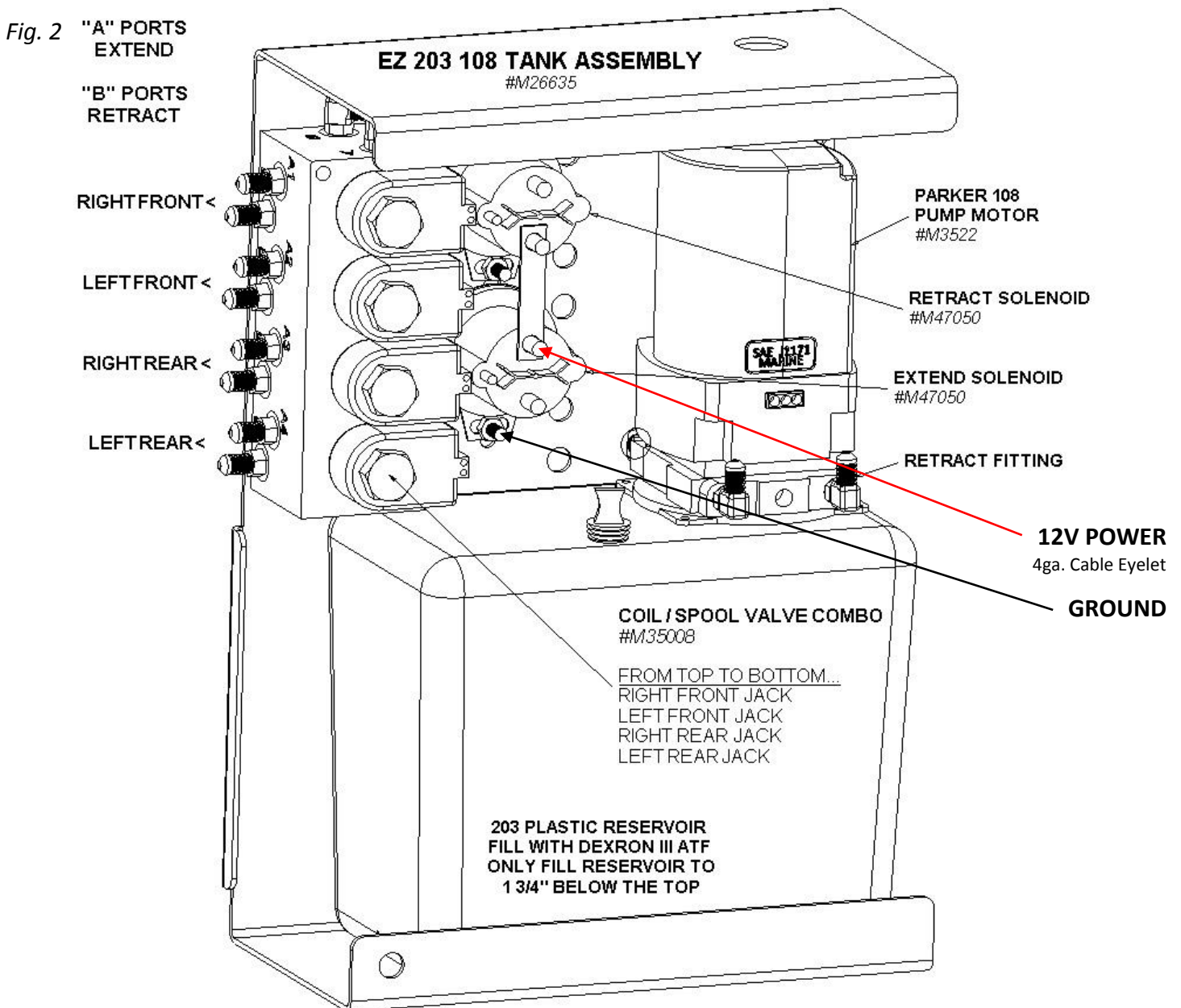

Central tank assembly is typically located near the "center" of the unit, Example: In front of rear axle on driver side frame rail (outside or between rails). Can be mounted to existing boxes, sub-frame, etc.



# MEDIUM TANK ASSEMBLY

#M26850

OVERALL DIMENSIONS:  
9" WIDE  
12.5" TALL  
5.75" DEEP

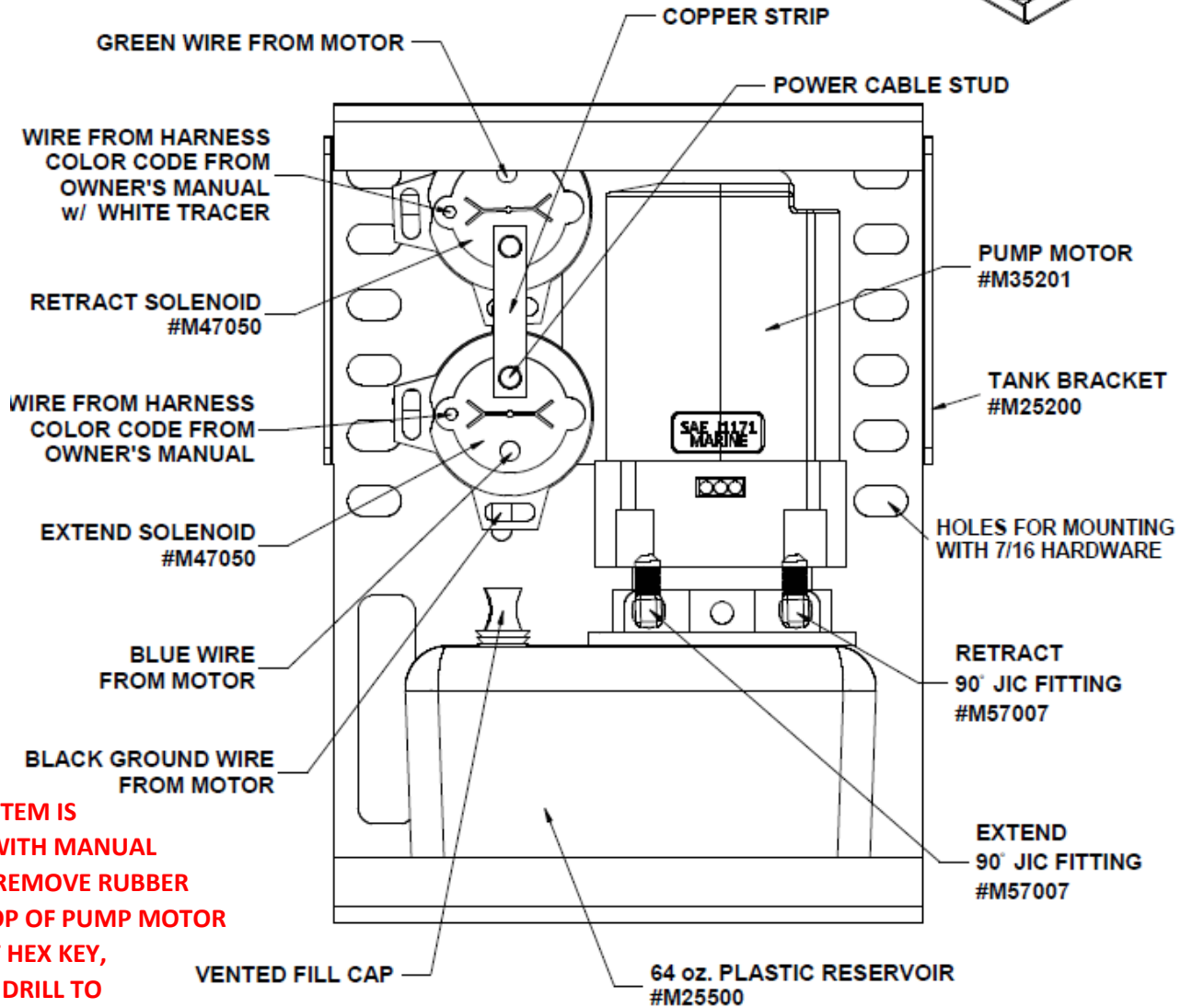
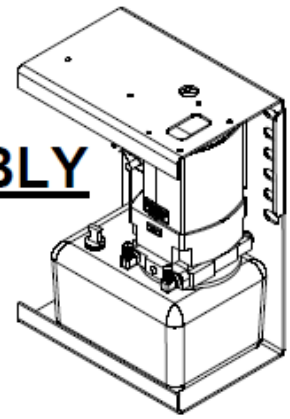

**IF YOUR SYSTEM IS EQUIPPED WITH MANUAL OVERRIDE, REMOVE RUBBER PLUG ON TOP OF PUMP MOTOR AND INSERT HEX KEY, TURN WITH DRILL TO OPERATE JACK UP/DOWN**

**4 PT WIRING HARNESS COLOR CODE DIAGRAM:**  
LEFT FRONT: GREEN/WHITE & GREEN  
RIGHT FRONT: BLUE/WHITE & BLUE  
LEFT REAR: GREY/WHITE & GREY  
RIGHT REAR: BROWN/WHITE & BROWN

**NOT PICTURED:**  
TANK COVER  
(BLACK TEXTURED PLASTIC)  
#M12002

## Mounting Tank Assemblies

Our tank assemblies are weather resistant and must be mounted vertically and can be mounted externally on the vehicle's frame by drilling holes in the frame or welding a bracket, tanks can be mounted to a cylinder bracket or inside a storage box. Use at minimum two 7/16" or 3/8" bolts per tank assembly. Take care when mounting and running hydraulic lines & wiring to avoid moving parts, exhaust, etc.

Example below of routing the Quad Pump Automatic & Manual systems 14-pin wire harness. The Central Pump Automatic & Platinum systems harness is similar except that the leads to each corner or jack have only a tan & black wire that plugs into the limit switch and the end of the harness with the 14-pin connector plugs into the pump while the end with the 14-pin & 6-pin connectors plug into the Automatic's Sensor or Platinum panel. Take care to avoid high heat areas and moving parts.

## MAIN WIRE HARNESS DIAGRAM

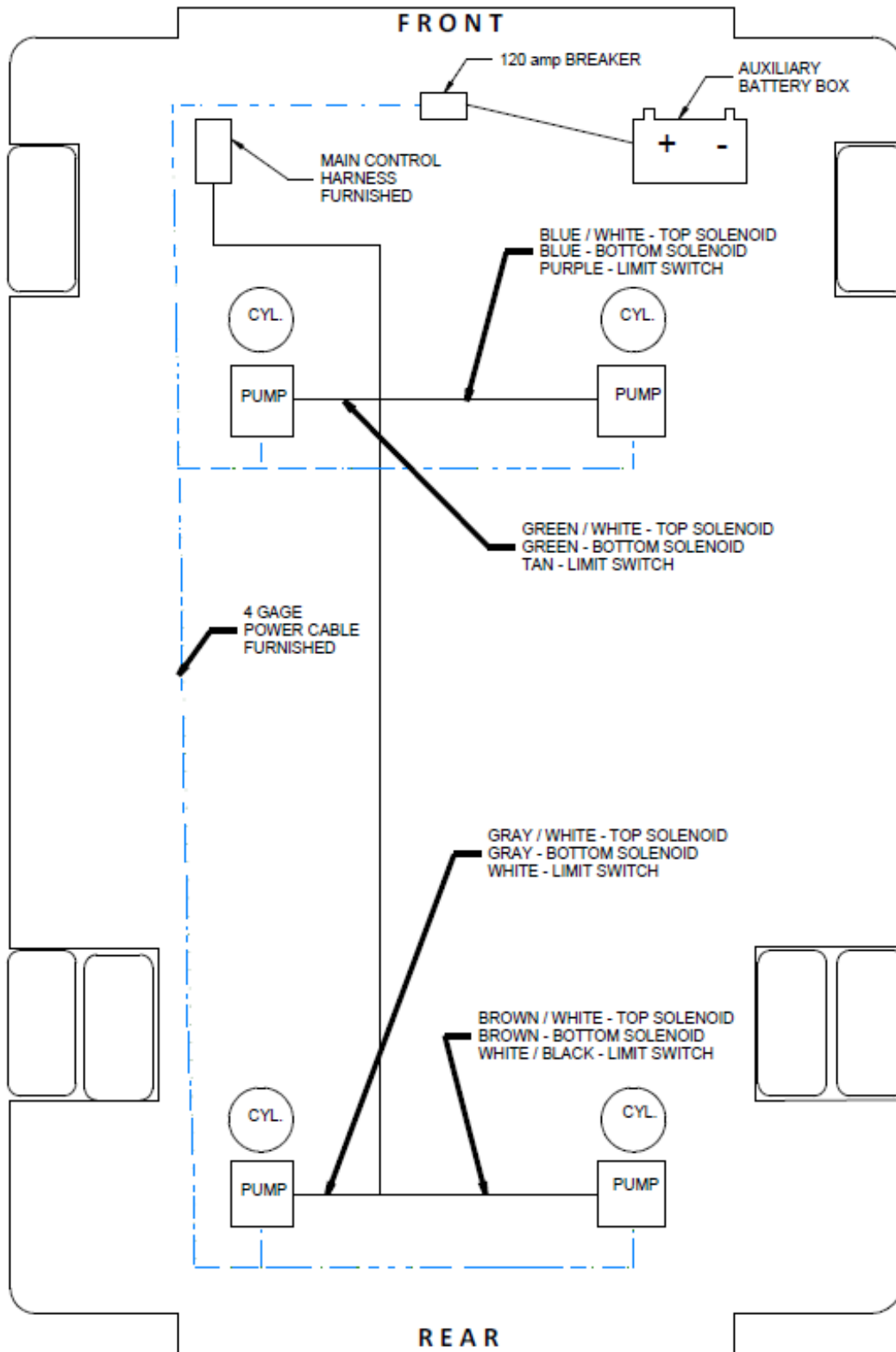

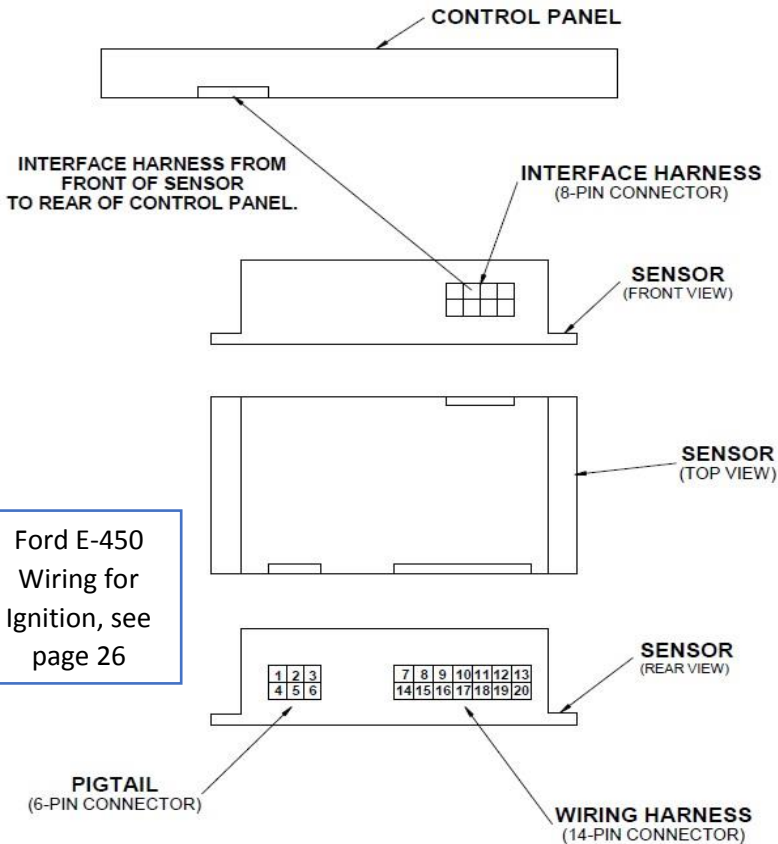

**Automatic Leveling Sensor & Control Panel:** Fasten the sensor to a secure structure: Typical location would be inside the cabinet near the entry door. It must be inside the vehicle or dry storage area (not weatherproof controls). Ensure that it is mounted level and the arrow on top of the sensor is facing the correct way. Included in most kits is a sensor mounting bracket, attach the sensor with the included #8-32 bolts & nuts. The bracket allows you to mount the sensor off the floor and to vertical surfaces as well, see Fig.33 inside the cabinet (removed drawer for easy access). Plug the 14-pin & 6-pin from the harnesses into the back side. The 6-pin connector only has needs the yellow wire to be hooked up for central pump systems. The yellow wire needs to tie into an ignition or accessory hot wire from the vehicle, see next pages for details. For quad pump systems, the red wire goes to fused 12V and black wire to ground. After doing so attach the interface harness (8-pin connector) to the front of the sensor and attach to the Control Panel. The panel is typically mounted near the side entry door, on a cabinet wall or panel somewhere inside the coach, or inside Quadra's optional plastic box assembly with the harness loosely coiled behind the driver's seat.

### Platinum Control Panel

Plug the 14-pin & 6-pin from the harness into the back side. There is a yellow wire coming from the 6-pin that needs to tie into an ignition hot wire from the vehicle. The panel may be mounted on the dash in a safe location or on a panel somewhere on inside the coach, or inside Quadra's plastic box assembly with the harness loosely coiled underneath the driver's seat.

### Battery Cable for Central Pump & 2pt Systems

Supplied will be a 4 gauge battery cable that needs to be cut into two pieces.

- The 1<sup>st</sup> to run from the Solenoid power stud (marked BATT+) to the 80 amp breaker AUX stud.
- The 2<sup>nd</sup> to run from the BAT stud on the breaker to the Positive Terminal on the coach's house battery. Hooking up the power should be the final wiring step so make sure this is done after all the other electrical work is done for safety. The supplied 80 amp breaker should be securely fastened in the battery box. Ground cable (attached to central pump assembly, typically white 10ga. wire should be fastened to vehicle frame or extended to negative terminal on battery.

### Battery Harness for Quad Pump Systems

Supplied will be a 4 gauge battery harness that must be ran from the coach's house battery to all four pump assemblies at the solenoid power stud (with the copper strip). For the end going to the breaker 120 amp auto resetting, then the positive terminal on battery.



**Manual Control Panel:** Plug the 14-pin harness & 6-pin into back of panel, mount with bezel, not weatherproof control or wire connection, mount inside with supplied #6 black screws. 6-pin has black needs ground, red to 12v constant and yellow to ignition hot.

## **Central Pump Final Extend Hose Installation & Bleeding the System**

---

During installation of the hydraulic lines, air is internally captured in the hose. Due to this, bleeding the air out of the system is necessary for the system to work properly. This process is done at the end of installation and requires two people and can be messy, so as a warning make sure you are wearing eye protection and have rags ready to use. Make sure all hose fittings are tight on the pump side and the retract side of the jacks. Extend hose fittings should still be un-installed.

- With person #1 running the panel, go into Manual Mode, all jacks should be fully retracted.
- Person #2 (armed with a 5/8" OR 9/16" wrench, safety glasses, rag and a one gallon container) needs to access the left rear jack and place the un-attached extend hose into the empty container.
- Now person #1 will extend that left rear jack from the panel (press & hold button).
- Fluid & air will be spilling out of the port, once a solid stream of fluid occurs, person #1 will release the button on the panel, after fluid stops flowing person #2 should install the hose fitting to the jack.
- Repeat these steps with the rest of the jacks.
- After doing so, extend all jacks fully and let stand for 15 minutes.
- Then retract all the jacks and remove the tank cover and check your fluid level to verify the fluid in the reservoir is around 1 3/4" below the top (ATF Dexron III) do not fill to the top!

Finally install the tank cover, check that all hardware is tight, the sensor is facing the correct way and is mounted level and the house battery is fully charged.

*In some instances, the front jacks may need to be dis-mounted from underneath the cab to access the top extend ports during the bleeding procedure.*

## **Bleeding Quad Pump systems**

---

In Manual mode, extend all four jacks to complete extension and leave in this position for 20 to 30 minutes. This pushes all the air out of the lines by weight pressure. After turn panel back on and press Retract.

## **Troubleshooting - Hydraulic Cylinder/Plumbing Related**

---

**What fluid do we use in the system?** Automatic Transmission Fluid Dexron III ATF

**Cylinders running "choppy"...** Bleed the system, if central pump system, try quad pump method first.

**Cylinders make loud "squeaking" noise while operating...** Spray rams with Teflon spray (dry lubricant).

**Hydraulic fluid on footpad or on ground around cylinder...** Loose fitting or broken hydraulic line.

**Cylinders "creep" down or don't hold pressure when lifting/holding coach...**

- Check fluid level, Check for leaks in hydraulic lines/fittings
- Possibly plumbed backwards... (Bottom port on cylinder tube connects to right port on pump, etc.)
- Relief Valves have failed on pump motor... replace motor/tank assembly
- Hydraulic seal failure, check for oil around bottom of cylinder or welds... replace cylinder

# Warranty Guide

---

**Owner must activate warranty!** Via Phone or Website

**OEM Level Auto Quad/Central System:** 1 year parts & labor (purchased by Tiffin, Coachmen, etc.)

**Platinum Central Pump System:** 1 year parts and labor.

**Automatic Leveling System:** Lifetime Cylinders, 2 years parts, 1 year labor.

**Manual Leveling Quad Pump System:** Lifetime Cylinders, 2 years parts, 1 year labor.

Should the product be defective due to workmanship and/or material flaws, we will repair/replace the defective material. **Core charges may be applied and refunded on certain components.**

## Quadra is NOT responsible for:

- ▶ **Freight on warranty parts.**
- ▶ **Replacing footpads, bolts, loose or bent brackets or fluids lost as a result of failure to maintain the system, Ex. loose/missing footpads, loose mounting brackets/hardware from not re-torquing after initial use, etc.**
- ▶ **Damages caused by abuse, misuse, negligence, misapplication, error of operation, accidental or purposeful damage or faulty installation. Including but limited to hoses, fittings & wiring components. Example, bent limit switch pins from hitting ground while driving, missing SnapPads, operating system with rear tires off the ground, modification to system, etc.**
- ▶ **Liability for loss to the vehicle, or apparatus or property, loss of time, manufacturing costs, labor, material, loss of profits, consequential damages (direct or indirect).**
- ▶ **For transportation to and from a service center, onsite service calls to or from the customer, damage from road hazard, loss of salaries, commissions, lodging, towing charges, bus fares, car rentals, fuel expense, telephone charges, inconvenience compensation while repairing or replacing a defective part or material.**

This warranty voids all previous issues. Effective date: 2/12/18

**OWNERSHIP MUST BE REGISTERED WITHIN 30 DAYS FROM THE DATE OF PURCHASE TO  
ACTIVATE WARRANTY. Do it online at [BIGFOOTLEVELER.com](http://BIGFOOTLEVELER.com)!**

Prior to any work being done an **authorization number must be obtained** by calling 269-483-9633 for Warranty Parts or Service Labor. For full warranty transcript just contact us!

Service labor based on a flat rate schedule determined by Quadra for **authorized** work performed will be reimbursed. This will eliminate much diagnostic time and avoid **refusal of unauthorized claims**. Many problems may be resolved by contacting a Quadra service representative.

**Provide the system serial number here** \_\_\_\_\_.

## **Emergency Service**

For afterhours emergency service please call our normal office number  
**269-483-9633** and follow the instructions.